

DEVELOPMENT OF SUNFLOWER SEEDS HULLING PROTOTYPE

Radwan, S. M.

Agric. Eng. Dept., Fac. of Agric., Suez Canal Univ. Ismailia

ABSTRACT

The main objective of this study is to develop and evaluate a hulling prototype of sunflower seeds. The evaluation was conducted in the matter of spinning disc speed, the material of spinning disc, the number of vanes on spinning disc, and the sunflower seeds moisture content. The results showed that, the hulling efficiency and broken kernels increased with the decreasing of the sunflower seeds moisture content. It was also cleared that, the hulling efficiency and broken kernels increased with the increasing of speed of the spinning disc and the number of vanes on spinning disc from 2 to 6 vanes. So, the best operational variables for the hulling prototype is; 5200 rpm (65.31 m/s) spinning disc speed with 6 vanes on the spinning disc. Meanwhile, the aluminum spinning disc resulted in the best hulling efficiency in comparison with the wood and iron materials. The electrical power consumption increased with the increasing of the spinning disc speeds for the three different spinning disc materials (aluminum, wood, and iron).

INTRODUCTION

Sunflower ranks as the second after soybeans with respect to oil production in the world. In Egypt, sunflower is consider a promising crop to face the shortage of vegetable oils because of its adaptability to grow in various soils and climatic conditions (Keshta *et al.*, 1992). The planted area of sunflower oil producing varieties is only 10385 feddan with total production of 10178 tones (Agric Stat.,2005). This area is too small to cover and meet the need of the Egyptian consumers of vegetable oil, so the Egyptian Agricultural strategies till 2017 plans to increase the area cultivated by the oil crops specially (canola and sunflower) by 200000 feddan to produce about 100000 tones oils. So this help in reducing the shortage of vegetable oil (970000 tones in 2007), Egyptian Agricultural strategies, 2004.

AOF (2005) reported that, sunflower seeds are one nature's most nutritious food. They are packed full of healthy unsaturated oil, protein and fiber, plus essential nutrients that help keep body in peak heath. The nutrient composition of raw sunflower seeds are: protein 23%, fat 51%, carbohydrate 25, fiber 11%.

Vavport (1999) reported that, the hull content of the sunflower seeds was ranged from 23 to 27%. The dehulling of the sunflower seeds before the oil extraction, up to about 10-12% residual hulls, constitutes an important stage in the oil industry. Partial dehulling of the seed originates relevant advantages such as a better quality of both the oil (lower wax and pigments content) and of the extract flour (an increase on the protein content and a decrease of raw fiber content); decreased volume of product to defat; a minor erosion of the presses.

The presence of fairly high proportion of hull in the seed (varies between 20-30%) depending on the variety and mostly contains crude fiber and insignificant quantity of fat; not only causes rapid wear of the moving

parts of the expeller but reduces the total oil yield also. Besides transferring pigments from the hull to the extracted oils shows consumption of high specific energy and yielding cakes of lower food value.

Amuthan *et al.* (2001) modified the centrifugal paddy huller for hulling sunflower seeds. Modifications were made on the impeller viz., number of vanes in the impeller, radius of curvature of the vanes and the peripheral speed of the impeller. He observed that centrifugal huller for paddy can be very well utilized for sunflower seed hulling with suitable modifications. The performance of the machine measured in terms of percent shelling efficiency was maximum at 87.72% with 4 vanes, 8 cm radius of curvature of the vanes at 2600 m/minute peripheral speed at 6.5% moisture content (w.b.) of the seed.

Nolasco *et al.* (2002) reported that, in the oil industry, the partial dehulling of the sunflower seeds constitutes a stage that originates relevant advantages such as a decreased volume of product to the fat; a minor erosion of the presses, better quality of both the oil and the extract flour. They also reported that, a decrease in the moisture content of seeds increases not only their ability for dehulling but also the amount of fines originated. This decrease also modified the fine composition and increasing its kernel proportion. The optimum moisture was approximately 3% getting the dehulling of about 53% of the seeds.

IDRC (1998) reported that hulling is a process of removing hulls from the oil bearing seeds for obtaining high quality edible oil by the processing of kernels. About 99% of oil is stored naturally in kernels and the hulls contain not more than 1% oil. If the hulls are not removed they reduce the total yield of oil by absorbing or retaining oil in the pressed cake. In addition to this the wax and coloring matters present in the hulls get mixed with the expressed edible oil. This necessitated the refining process, and therefore, increase the production cost of edible oil.

Subramanian *et al.* (1990) reported that, shelling efficiency and percent fines of sunflower seed increased with (i) increase in size of seed, (ii) increase in impeller speed, (iii) decrease in feed rate, and (iv) decrease in the seed moisture content.

Gupta and Das. (1999) reported that, the performance of the centrifugal dehulling system was found to be influenced by the moisture content of the seed or kernel (4 -14 db), peripheral speed of the impeller (34 – 45 m/s) and feed rate (20- 200 kg/h). The overall performance was expressed in terms of dehulling efficiency, percent non-recoverable kernel fraction and specific energy consumption. Dehulling efficiency increased with (i) increase in impeller speed (ii) decrease in feed rate, and (iii) decrease in the seed moisture content. The best dehulling performance could be obtained if the system is operated at peripheral speed of 40.7 – 44.5 m/s and feed rate of 100 kg/h using medium size seed with moisture content of 5.3%-8.0% db. Under these conditions, the values of dehulling efficiency and specific energy consumption were 69-77% and 3.1-3.8 kJ/kg.

Gupta and Das. (2000) measured the fracture resistance of both a sunflower seed (*Helianthus annuus* L.) and its kernel in terms of average compressive force, deformation and energy absorbed per unit volume at

rupture. Samples at various moisture content were loaded in vertical and horizontal orientations. The force required for seed hull or kernel rupture decreased as moisture content increased from 4% to 20% d.b. Seeds loaded in the horizontal orientation developed hull cracks at a lower level of force than those loaded in the vertical orientation. For the kernel, the trend was the opposite. The average compressive forces required to cause kernel rupture were substantially lower than those required to rupture the seed in both orientations.

Das and Gupta (2005) studied the performance of the sunflower seeds huller (centrifugal huller). Their results showed that, the forward curved impeller vanes made of aluminum gave higher dehulling efficiency than that with mild steel or rubber vanes.

Tayel and Khairy (1988) designed and constructed a prototype of mechanical sheller for sunflower seeds depending on centrifugal action to produce impact and friction forces. They found that, the most important factors are spinning disc speed, diameter of spinning disc and the friction coefficient between seeds and the impact surface. They also mentioned that, the shelling operation depends largely on the impact force and partially on friction force. The friction coefficient had a small effect, so the impact surface must be mad from rigid and rough materials.

The objective of the present work is to develop a centrifugal hulling prototype suitable for the small seeds like sunflower seeds and to study the parameters affecting the hulling efficiency of the developed prototype to set the optimum operating parameter for the highest hulling efficiency.

THEORETICAL ANALYSIS

The sunflower seeds hulling efficiency is depending on the seeds conditions as well as the machine engineering parameters. The mathematical analysis, take the machine engineering parameters only into consideration. For the prototype under the study, since the sunflower seeds fall from rest through a short distance to the spinning disc. So there are tow probabilities of the seeds movement over the spinning disc. First, the seeds rest on the spinning disc surface and then the seeds and the drum angular speed are equal. At this case, the hulling process could be done by the centrifugal force (Fc). This force is calculated from the following equation:

$$F_c = m \omega^2 r \dots\dots\dots(1)$$

The second probability is the vanes hit the seeds before reach the spinning disc (radial force) and this radial force (Fr) is calculated form the equation of (Atolagbe, 1991) as follows:

$$F_r = I \alpha / r \dots\dots\dots(2)$$

Where:

- m = Seed mass, kg
- ω = Angular velocity, $S^{-1} = 2 \pi n$
- r = Spinning disc radius, m
- n = Spinning disc speed, rpm
- I = Moment of inertia ($kg.m^2$)

α = Momentary relative angular deceleration due to the presence of sunflower (radians/sec²)

For the first probability the theoretical hulling force was calculated according to the diameter of the spinning disc (0.12 m), mass of sunflower seeds at different levels of seed moisture content of (6.1, 7.9, 10.2, 12.3 and 13.8%) which equal to (0.077, 0.785, 0.0801, 0.0816 and 0.0831 g), respectively and different levels of spinning disc speed of 2500, 3200, 4600 and 5200 rpm, which equal to (31.4, 40.19, 57.78, and 65.31 m/s, respectively). Fig.(1) shows the theoretical hulling force (centrifugal force) for the prototype at different seed moisture contents and different speeds of spinning disc. As shown in the figure, the theoretical hulling force increased with the increasing of seeds moisture content as well as the spinning disc speed. In other words, the prototype at 5200 rpm (65.31 m/s) showed the highest theoretical centrifugal force (3.01 N). It can also notice from the Fig. that, theoretically the prototype has the opportunity to hull all the seeds rested on the spinning disc which had the same speed of the spinning disc. The practically unhulled seeds percentage could be related to the over load of seeds on spinning disc, so, may some seeds pass through the clearance between spinning disc and the cylinder and or some seeds slipped or jumped over the spinning disc to the charge opening of the prototype.

To improve the hulling efficiency of the prototype, different spinning disc materials were tested (iron, aluminum and wood). This may give the seeds the opportunity to move on the disc surface to its edge. So the centrifugal force increased and the hulling efficiency increased. Table (1) presents the coefficient of friction between different material of spinning disc and sunflower seeds at different levels of seeds moisture content. As shown in the table, the Aluminum material showed the lowest coefficient of friction followed by wood and iron. The table also shows that, the coefficient of friction between the spinning disc material and seeds increased with the increasing of sunflower seeds moisture content.

Table (1): The coefficient of friction for different material of spinning disc at different levels of seeds moisture content.

Moisture content (w.b), %	Coefficient of friction		
	Wood	Iron	Aluminum
6.1	0.44	0.58	0.38
7.9	0.49	0.60	0.43
10.2	0.55	0.65	0.47
12.3	0.60	0.73	0.49
13.8	0.68	0.75	0.53

For the second probability, which the vanes hit the seeds before it reaches the spinning disc (radial force), Fig. (2) shows the theoretical radial force using different kinds of spinning disc material and assuming that the vanes hit the seeds at different spinning disc radiuses (0.03, 0.06, 0.09 and 0.12 m) and different speeds of spinning disc. As shown in the Fig., the theoretical radial force increased with increasing the spinning disc speed for all the assumed spinning disc radiuses and spinning disc materials.

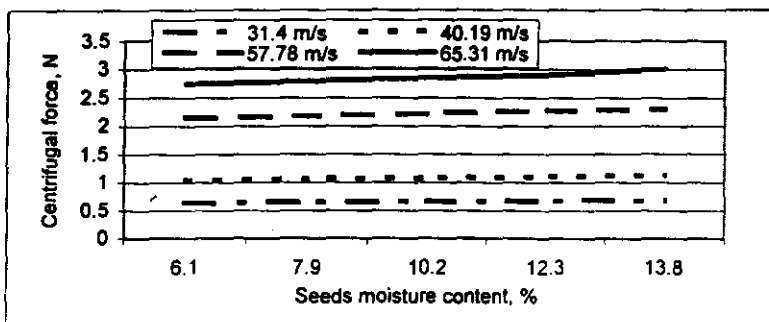
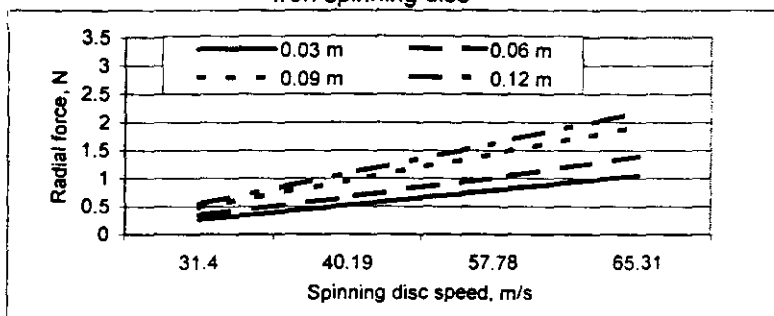
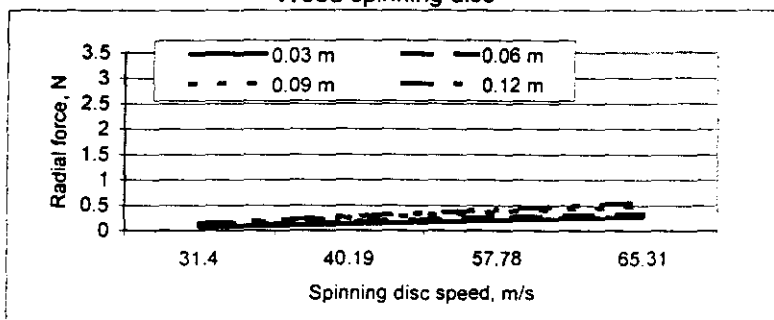

Fig. (1): The theoretical hulling force (centrifugal) at different speeds and seeds moisture content
Iron spinning disc



Wood spinning disc



Aluminum spinning disc

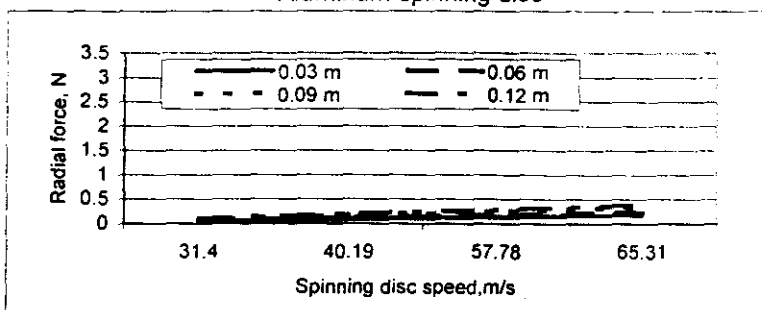

Fig. (2): The theoretical radial force at different spinning disc radius and different disc materials

It can also be seen in the Fig. that, the iron disc showed the highest theoretical radial force followed by the wooden disc and finally the aluminum disc. From Figs. (1 and 2), it can be noticed that, the centrifugal force is higher than the radial force. So, to increase the hulling efficiency it's important to keep the centrifugal force into consideration and neglect the radial force. Therefore, a cover disc over the spinning disc is strongly recommended to keep the seeds away from hitting by the vanes and spread the seeds over the spinning disc.

MATERIAL AND METHODS

3.1 Sunflower seeds

Sunflower seeds (Sakha 35) were used in this experiment. The seeds were obtained from the experimental farm of Rice Mechanization Center at Meat El-Dybal, Kafr El-Sheikh Governorate. The seeds were cleaned manually from foreign matter and immature seeds. The samples were mixed and the initial moisture content of the seeds was determined. The sunflower seeds were dried under shade for the desired levels of moisture content for each experimental run. The dried seeds were then sealed in polyethylene bags. The bags were stored in a refrigerator at around $-5 \pm 1^{\circ}$ C to prevent moisture loss and fungal growth. Before each run, the required quantities of seeds were taken out from the refrigerator and allowed to attain the normal room temperature.

3.2 The hulling prototype

The hulling prototype (plate 1 and Fig. 3) was constructed and fabricated in the workshop of Agric. Eng. Dept. Faculty of Ag. Suez Canal Univ. The prototype consists of a spinning disc connected with a vertical 2.5 cm diameter spindle which rotate at different speeds through a transmission pulleys. Another disc was mounted above the spinning disc with adjustable clearance to keep the seed always over the spinning disc. The spinning disc surrounded by a steel cylinder with diameter of 28 cm and height of 50 cm. The spinning disc was made of three different materials, namely aluminum, wood and iron with diameter of 0.24 m. Each spinning disc has up to 6 vanes made of the same material. The hulling prototype was driven by a 0.75 kW electrical motor.

3.3 Experimental treatments and procedure

The experimental treatments included, seeds moistures content (6.1, 7.9, 10.2, 12.3 and 13.8%), spinning disc speeds (2500, 3200, 4600 and 5200 rpm) which equal to (31.4, 40.19, 57.78, and 65.31 m/s, respectively) and number of vanes on spinning disc (2, 4 and 6). The hulling prototype was run in the beginning of the experimental process for 5 minutes to come to the steady state. Sunflower seeds were fed in the hulling prototype while the power consumption was measured. The output of the prototype was collected and random samples of the outlets were taken to evaluate the prototype performance at different parameters.

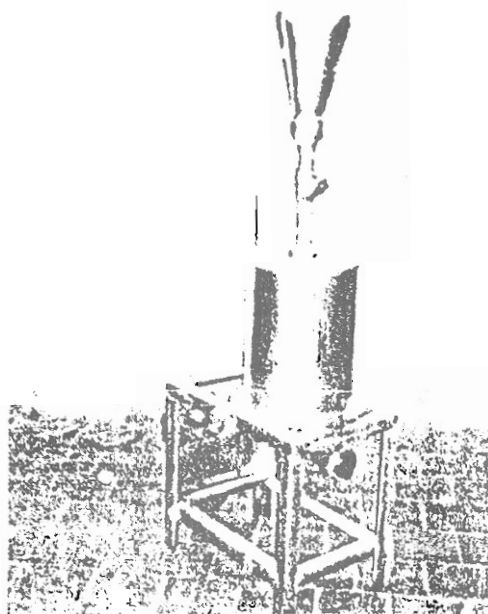

Plate (1): Configuration of the sunflower hulling prototype

1. Hopper
2. Disc cover
3. Spinning disc
4. Cylinder
5. Spindle
6. Motor
7. Outlet
8. Stand

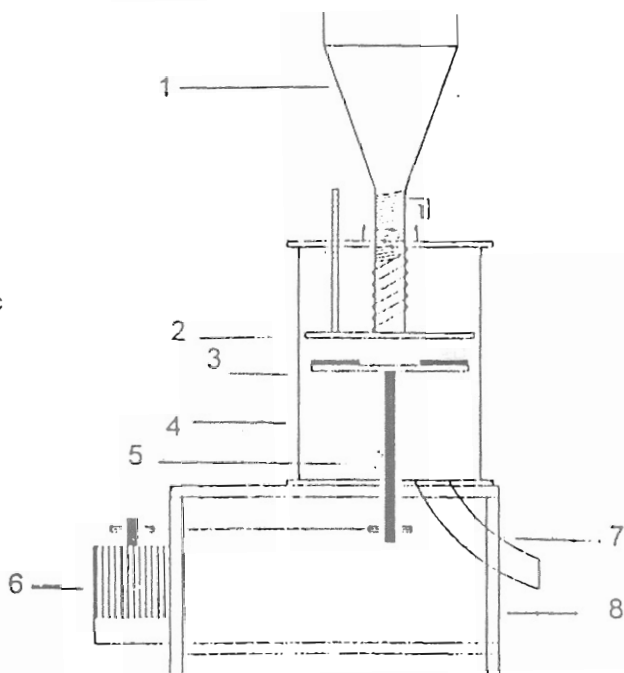

Fig. (3): Sketch of the hulling prototype

3.4 Measurements and calculations

3.4.1 Seeds mass and principal dimensions

A vernier caliper with accuracy of 0.01 was used to measure the principal dimensions of the sunflower seeds. For measure the mass of the seed, an electric balance with accuracy of 0.01 g was used.

3.4.2 Seeds moisture content (MC)

Sunflower seeds moisture content (MC) was determine by the standard air oven drying method (ASAE Standard, 2003) using 10 g seeds sample placed in air oven at $130 \pm 1^\circ \text{C}$ for 3 h. The resulted moisture content was average of three replicates. It should be mention that all moisture contents presented in this paper are expressed in wet basis, otherwise will be mentioned.

3.4.3 Energy required for hulling sunflower seeds

The energy consumption (kWh) for each treatment was measured during hulling process with WSE, Bedienungsanleitung LVM 210 energy consumption meter.

3.4.4 Hulling efficiency

Hulling efficiency (E) was calculated according to Tayel and Khairy (1998) as follow:

$$E \% = (1 - W_1/W) \times 100 \dots\dots\dots(3)$$

Where:

W_1 = Unhulled seeds, kg

W = Total weight of sample, kg

3.4.5 Broken percent

The broken kernels percent (B) were calculated using the following formula:

$$B \% = (b/W) \times 100 \dots\dots\dots(4)$$

Where:

b = Broken kernels, kg

RESULTS AND DISCUSSION

4.1 Hulling efficiency of the prototype

Figs. (4 and 5) illustrate the effect of seeds moisture content and number of vanes on spinning disc on hulling efficiency of the prototype at different spinning disc speeds. As shown in the Fig., the hulling efficiency decreased with the increasing of seeds moisture content for the four studied spinning disc speeds. The sunflower seeds at the lowest seeds moisture content of 6.1% and the highest spinning disc speed of 5200 rpm (65.31 m/s) showed the highest hulling efficiency of (81.2%). On the other hand, sunflower seeds at the highest seeds moisture content of 13.8% and the lowest spinning disc speed of 2500 rpm (31.4 m/s) showed the lowest hulling efficiency of (17.1%). This results could be related to the mechanical properties of the seeds as reported by Gupta and Das., 2000 which seeds loaded in the horizontal orientation developed hull cracks at a lower level of force than those loaded in the vertical orientation. Also the increasing in the spinning disc sped increased the centrifugal force and thereby increasing the hulling efficiency.

2 vanes

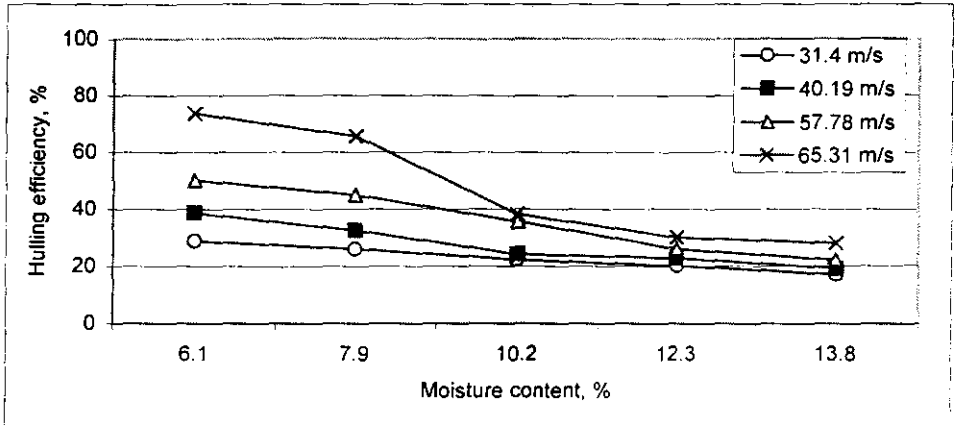

4 vanes

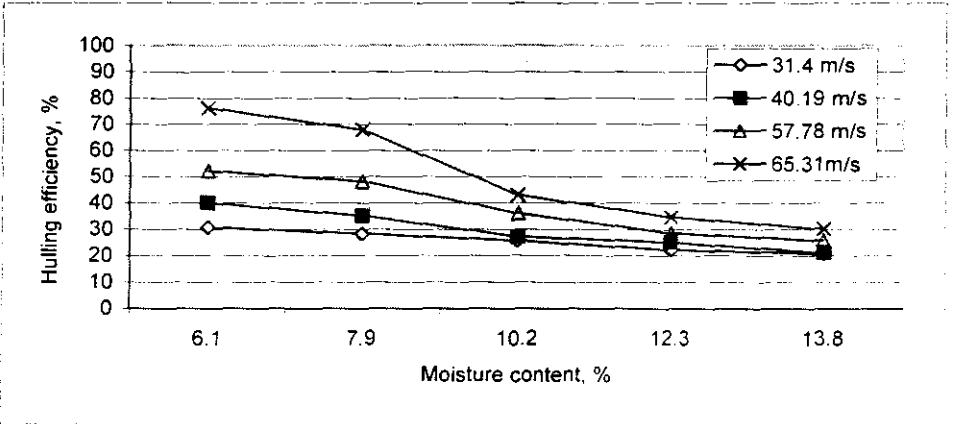

6 vanes

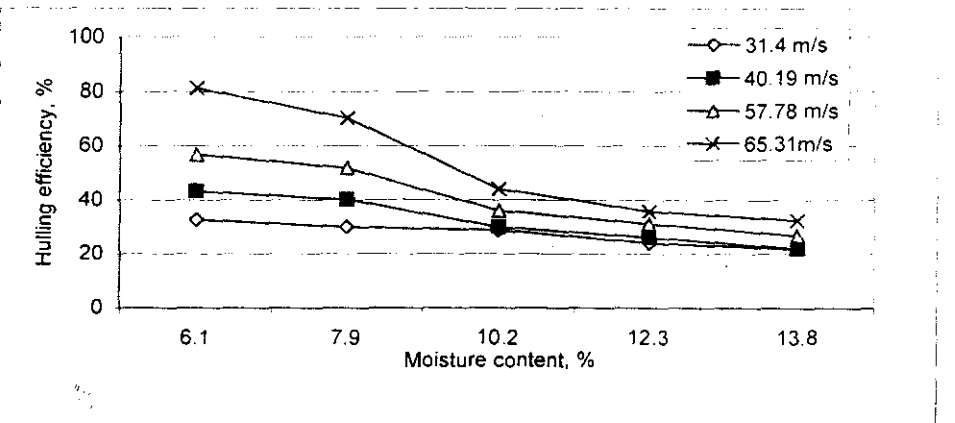

Fig.(4): The effect of seeds moisture content on hulling efficiency at different spinning disc speeds and different number of vanes

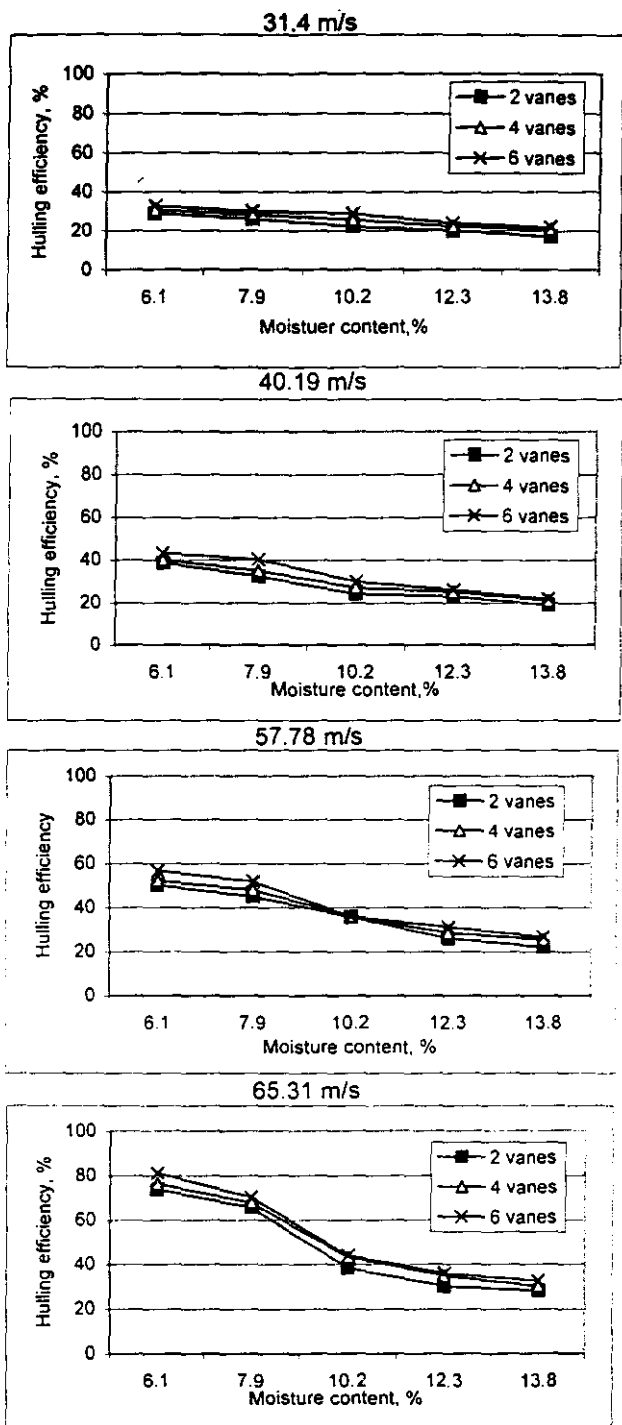

Fig. (5): The effect of seeds moisture content on hulling efficiency at different number of vanes

The effect of number of vanes on spinning disc on hulling efficiency of the proposed prototype at different levels of spinning disc speed and seeds moisture content is shown in Fig. (5). As shown in the Fig., the hulling efficiency decreased with the increasing of seeds moisture content and spinning disc speed for all number of vanes used in this study. However, for all levels of seeds moisture content and spinning disc speed, the hulling efficiency was increased with the increase of number of vanes on the spinning disc. The recorded hulling efficiency at the maximum spinning disc speed of 5200 rpm (65.31 m/s) and minimum grain moisture content of 6.1% were 73.7, 76.3 and 81.2% for using 2, 4, and 6 vanes respectively. However, the corresponded hulling efficiency at the minimum spinning disc speed of 2500 rpm (31.4 m/s) and the highest seeds moisture content of 13.8% were 17.1, 20.7 and 21.8% for using 2, 4, and 6 vanes, respectively. On other words, it can be said that, sunflower seeds at 6.1% moisture content, 5200 rpm (65.31 m/s) spinning disc speed and 6 vanes on spinning disc resulted in the highest hulling efficiency of (81.2%). On the other hand, sunflower seeds at 13.8% moisture content, 2500 rpm (31.4 m/s) spinning disc and 2 vanes on spinning disc resulted in the lowest hulling efficiency of (17.1%).

4.2 Broken percentage of the hulled seeds

Its so important to mention that, the broken sunflower seeds is not consider as a losses in oil extraction industry. The oil extraction depending on pressing all the resulted hulled seeds including whole and broken seeds.

Figs. (6 and 7) present the effect of seeds moisture content and number of vanes on spinning disc on broken percentage of dehulled seed at the four spinning disc speeds under the study. As shown in Fig. (6), the broken percentage decreased with the increasing of seeds moisture content for all the studied spinning disc speeds. The lowest broken percentage of (4.3%) was obtained at minimum spinning disc speed of 2500 rpm (31.4 m/s) and the maximum seeds moisture content of 13.8%. While, the maximum broken percentages of (20.3%) was obtained at the maximum spinning disc of 5200 rpm (65.31 m/s) and the minimum seeds moisture content of 6.1%. The sunflower seeds at 6.1% moisture content results in the highest broken percentage (20.3%). This results could be related to the increasing of hulling efficiency in this level of seeds moisture content and according to Gupta and Das., 2000 which reported that, the force required for kernel rupture decreased as moisture content increased from 4% to 20% (d.b).

The effect of seed moisture content on broken percentage at different number of vanes on spinning disc is shown in Fig. (7). As shown in the Fig., the broken percentage increased with the increasing of number of vanes on spinning disc at all levels of seeds moisture content and speeds of spinning disc. For the minimum seeds moisture content of 6.1% and the maximum spinning disc speed of 5200 rpm (65.31 m/s), the recorded broken seeds percentages were 15.6, 17.7 and 20.3% for 2, 4 and 6 vanes. While, at maximum seeds moisture content of 13.8% and minimum spinning disc speed of 2500 rpm (31.4 m/s), the recorded broken seeds percentages were 4.3, 5.2 and 5.9% for 2, 4 and 6 vanes, respectively. In general it can be said that, the highest broken percentage was obtained at seed moisture content of 6.1%, 6 vanes on the spinning disc and 5200 rpm (65.31 m/s) spinning disc speed.

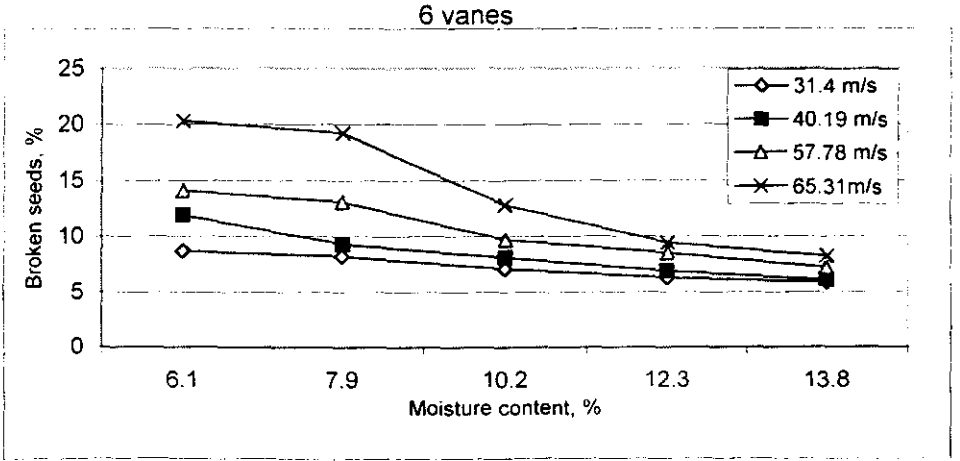
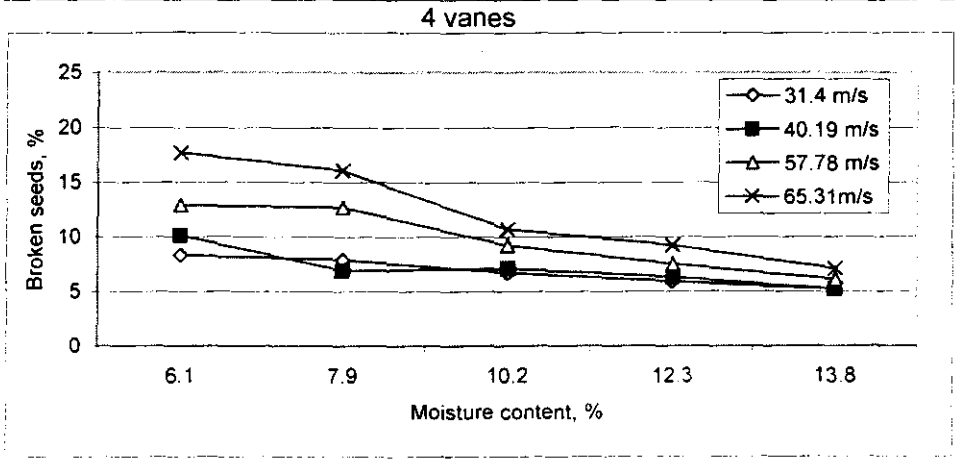
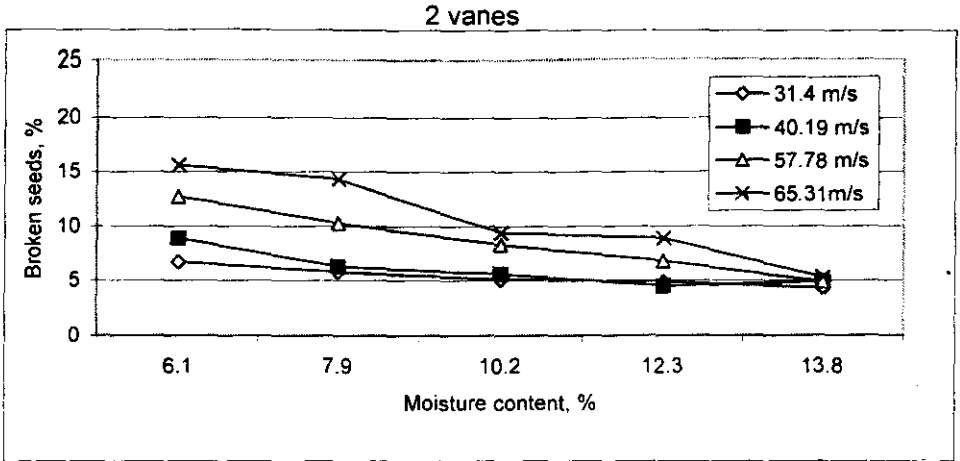

Fig.(6):The effect of seeds moisture content and spinning disc speeds on broken seeds percentage at different number of vanes

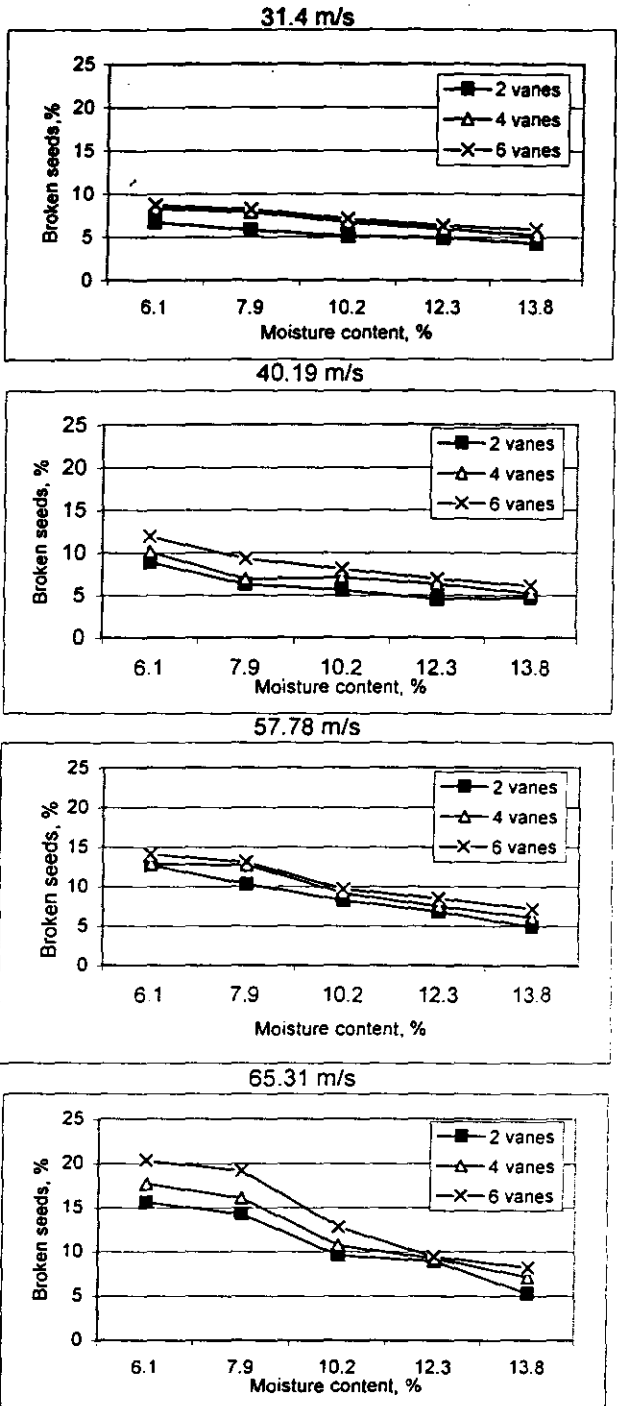

Fig. (7): The effect of seeds moisture content on broken percentage at different number of vanes on spinning disc

While, the maximum broken percentage was obtained at 13.8% seeds moisture content, 2500 rpm (31.4 m/s) and 2 vanes on spinning disc.

4.3 The effect of the material of spinning disc on the performance of the prototype

Two other materials (aluminum and wood) of the spinning disc were evaluated besides the iron disc material in term of hulling efficiency, broken percentage and power consumption. The evaluation tests were carried out at the lowest seeds moisture content of (6.1%), the highest spinning disc speed of 5200 rpm (65.31 m/s) and the spinning disc at 6 vanes which resulted in the highest values of hulling efficiency and lowest values of broken percentage.

As shown in Fig. (8), the hulling efficiency increased with the increasing of the spinning disc speed from 2500 to 5200 rpm (31.4 to 65.31 m/s) for all the materials under study. It can also seen that the aluminum spinning disc resulted in the highest values of hulling efficiency (89.8%) compared with the iron disc (81.2%) at the 6.1% seeds moisture content, 6 vanes on disc and 5200 rpm (65.31 m/s) spinning disc speed. On the other hand, the wooden spinning disc resulted in the lowest values of the hulling efficiency (38.8%) at the same seeds moisture content (6.1%), number of vanes on spinning disc (6 vanes) and spinning disc speed of 5200 rpm (65.31 m/s).

The effect of the material of the spinning disc on broken percentage is shown in Fig. (9). As shown in the Fig., the broken percentage slightly increased by using the aluminum disc compared to the iron disc. On the other hand, the wooden disc resulted in the lowest values of broken percentage.

The power consumption was measured for the three material of the spinning disc under study (Fig. 10). As shown in the Fig., the power consumption increased with the increasing of spinning disc speeds for the three disc material at constant seeds moisture content of (6.1%). It can also seen in the Fig., that, the aluminum disc recorded the lowest power consumption compared with the other tow material. This result could be attributed to the lowest weight of aluminum disc (362 g) compared with iron disc (1995 g) and wooden disc (510 g).

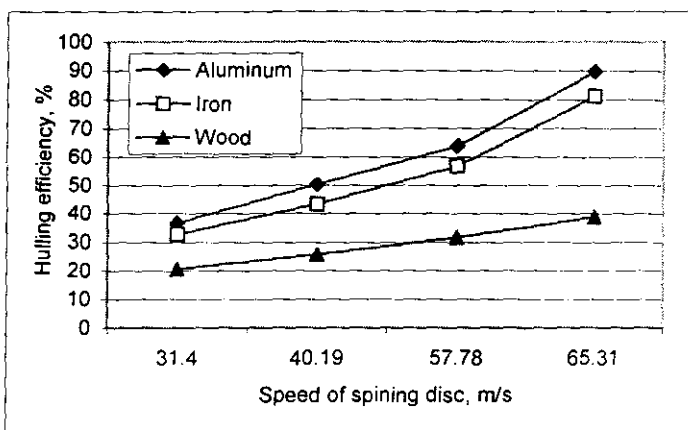

Fig. (8): The effect of spinning disc materials on hulling efficiency at different spinning disc speeds

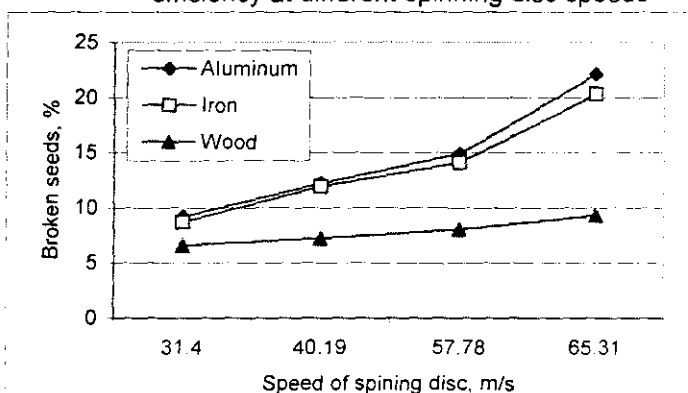

Fig. (9): The effect of spinning disc materials on broken percentage at different spinning disc speeds

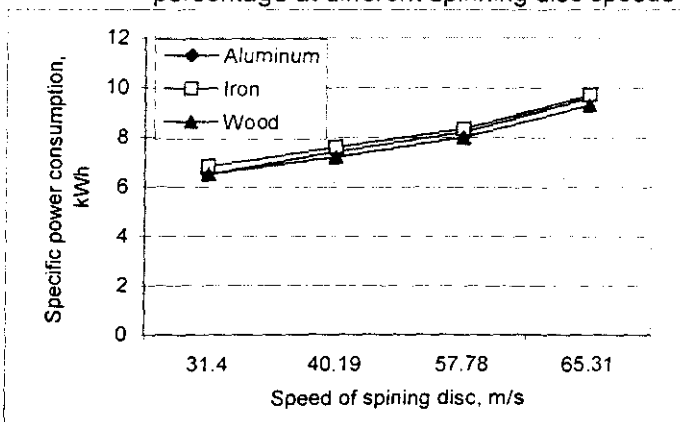

Fig. (10): The effect of spinning disc materials on power consumption at different different spinning disc speeds

Conlousion And Recommendations

From the results of the present study, it could be concluded that:

1. The hulling efficiency and broken percentage of seeds increased with the decreasing of sunflowers seeds moisture content from 13.8 to 6.1% (w.b).
2. The hulling efficiency and broken percentage of seeds increased with the increasing of spinning disc speed from 2500 to 5200 rpm (31.4 to 65.31 m/s).
3. The hulling efficiency and broken percentage of seeds increased with the increasing of number of vanes on spinning disc from 2 two 6 vanes.
4. The best operational variables for the hulling prototype is; 5200 rpm (65.31 m/s) spinning disc speed with 6 vanes on spinning disc.
5. The aluminum disc is strongly recommend because of its ability for hulling sunflower seeds.

REFREENCESS

- Agric Stat. 2005. Agricultural Statistics, summer and Nile crops. Arab Republic of Egypt. Ministry of Agriculture and Land Reclamation. pp155-159. Egypt.
- Amuthan, G; P.T. Palaniswamy; P. Subramanian. 2001. Modifications made on centrifugal paddy sheller for sunflower seed shelling. *AMA, Agricultural Mechanization in Asia, Africa and Latin America*.32(3): 51-53
- AOF. 2005. Australian oilseed federation. Nutrition fact sheets. No 8. January 2005. <http://australianoilseeds.com.28/8/2005>.
- ASAE, Standard. 2003. Moisture content, Unground grain and seeds. American society of Agricultural Engineers. St Joseph, Mi, USA.
- Atolagbe, S.O. 1991. Mathematical model of rice huller's rubber rolls. *Agricultural Mechanization in Asia, Africa, and Latin America*, Vol. 22, No.3, 49:50.
- Das, S.K. and R.K. Gupta. 2005. Effect of impeller vane configurations and seed size on dehulling efficiency of sunflower seeds using a centrifugal sheller. *International Journal of Food Engineering*. Vol.(1), Issue 3, article 7.
- Egyptian Agricultural strategies. 2004. Arab Republic of Egypt. Ministry of Agriculture and Land Reclamation. Pp 3-34. Egypt.
- Gupta, R.K. and S.K. Das. 1999. Performance of centrifugal dehulling of sunflower seeds. *Journal of Food Engineering*. Vol. (42), Issue 4, Pages 191-198.
- Gupta, R.K. and S.K. Das. 2000. Fracture resistance of sunflower seed and kernel to compressive loading. *Journal of Food Engineering*. Vol. (46), Issue 1, Pages 1-8.
- IDRC. 1998. International Development Research Centre, Ottawa, Canada www.idrc.ca/library/document.3/3/2006.
- Keshta, M.M.; A.M. El-Wakil and W.I. Souror. 1992. Response of some sunflower entries to hill spacing. *J. Agric. Sc. Mansoura Univ.*, 18 (3):620-627.

- Nolasco, S. M., Riccobene, Isabel C., Fernandez, M. Belén. 2002. Dehulling of high oil sunflower seed grown in Argentina. Paper number 026123, 2002 ASAE Annual Meeting. Published by the American Society of Agricultural and Biological Engineers, St. Joseph, Michigan. www.asabe.org.
- Subramanian, R.; M.C. Shamanthaka and K.Venkateshmurthy.1990. Impact dehulling of sunflower seeds: Effect of operating conditions and seed characteristics. Journal of Food Engineering. Vol. (12), Issue 2, pages 83-94.
- Tayel, S.A. and M.F.A. Khairy. 1988. A study on some design criteria of sunflower shelling machine. Misr. J.Ag.Eng.,5(3):307-316.
- Vavport Vicent, J. 1999. El prensado mecanico. Principios basicos. Mantenimiento y futuro de un proceso tradicional. Grasas y Aceites.34:65-76. Cited by Nolasco, S. M., Riccobene, Isabel C., Fernandez, M. Belén. 2002. Dehulling of high oil sunflower seed grown in Argentina. Paper number 026123, 2002 ASAE Annual Meeting.

نموذج لتقشير بذور عباد الشمس

شريف محمد عبد الحق رضوان

قسم الهندسة الزراعية-كلية الزراعة - جامعة قناة السويس - الإسماعيلية

يعتبر محصول عباد الشمس من المحاصيل الزيتية الهامة والواعد في العالم عامة ومصر خاصة لاحتواء بذوره على نسبة عالية من الزيت تصل إلى ٥٠% كما وأن لمحصول دوار الشمس القدرة على النمو في مختلف الأراضي والأجواء. وتهدف الاستراتيجية الزراعية المصرية حتى عام ٢٠٠٧ إلى زراعة ما يقرب من ٢٠٠ ألف فدان تنتج حوالي ١٠٠ ألف طن من بذور المحاصيل الزيتية وخاصة الكانولا ودوار الشمس لمواجهة الفجوة الزيتية الكبيرة في الأسواق المصرية ولتقليل الإنفاق في استيراد الزيوت من الخارج. وتعتبر عملية تقشير بذور عباد الشمس قبل إجراء عملية الاستخلاص الميكانيكي من العمليات الهامة جدا حيث أن استخلاص الزيوت من البذور الغير مقشرة ينتج عنه زيوت منخفضة الجودة. لذلك كان الهدف من هذه الدراسة هو تطوير نموذج لتقشير البذور الصغيرة مثل بذور عباد الشمس ودراسة العوامل المختلفة التي تؤثر على كفاءة التقشير وكسر البذور والقدرة المستهلكة.

تم تصنيع نموذج بسيط لتقشير بذور عباد الشمس بورشة قسم الهندسة الزراعية - كلية الزراعة - جامعة قناة السويس وتم اختبار كفاءة النموذج تحت تأثير ٤ مستويات من سرعة دوران قرص التقشير هي ٢٥٠٠ ، ٣٢٠٠ ، ٤٦٠٠ ، ٥٢٠٠ لفة/دقيقة (٤، ٣١، ٤٠، ١٩، ٥٧، ٧٨، ٦٥، ٣١ م/ث)، ٣ مستويات من عدد الريش على قرص التقشير هي ٢ ريشة، ٤ ريشة، ٦ ريشة وقد تم إجراء التجارب على ٥ مستويات من المحتوى الرطوبي للبذور دوار الشمس هي ٦،١، ٧،٩، ١٢،٣، ٢٠، ١٣،٨% على أساس رطب. وقد توصلت الدراسة إلى النتائج التالية:-

- ١- تزداد كفاءة التقشير بنقص المحتوى الرطوبي للبذور بينما تزيد نسبة البذور المكسورة
- ٢- تزداد كفاءة التقشير بزيادة عدد الريش على قرص التقشير الدوار من ٢ إلى ٦ ريشة و بزيادة سرعة دوران قرص التقشير.
- ٣- تقل نسبة البذور المكسورة بنقص عدد الريش على قرص التقشير الدوار وانخفاض سرعة دوران قرص التقشير.
- ٤- تزداد القدرة المستهلكة في تقشير البذور بزيادة سرعة دوران قرص التقشير.
- ٥- قرص التقشير مصنوع من الألومنيوم أعطى نتائج أعلى في التقشير من القرص الحديدي والقرص الخشبي.