

AERO-DYNAMICS AND MECHANICAL PROPERTIES OF SOME OIL PRODUCING CROPS

Matouk, A.M.; S.M. Abd El-atif and A. Tharwat

Dept. of Agricultural Engineering, Fac. of Agric., Mansoura Univ.

ABSTRACT

Aero-dynamic and mechanical properties such as terminal velocity, Reynold's No. drag coefficient, coefficient of friction, repose angle and seeds hardness for three different oil producing crops (sunflower, soybean and canola) were determined at five different levels of seeds moisture content; while, shear force and shear stress of soybean hulls and cotyledons were also determined at the proper moisture content for oil extraction. The obtained results show that, for aerodynamic properties, both of terminal velocity and Reynold's Number of all studied crops increased linearly with the increase of seeds moisture content. While, drag coefficient decreased with the increase of terminal velocity. However, coefficient of friction was varied with seeds moisture content and type of friction surface. Also, it was increased with the increase of seeds moisture content. Meanwhile, stainless steel surface recorded the lowest values of friction coefficient whereas the rubber surface recorded the highest values. Also, the angle of repose increased with the increasing of moisture content. While, seed hardness decreased with the increase of moisture content. However, both of shear force and shear stress of soybean hulls and cotyledons were higher in the longitudinal direction as compared with the lateral direction.

Mathematical relationships were also developed for the different studied crops to relate the change in seeds moisture content with the obtained values of all aerodynamics and mechanical properties.

INTRODUCTION

Mechanical properties of oil seeds are important to design equipments for dehulling, shelling, and oil extraction, and also in other processes like, transportation and storage. Static friction coefficient of various surfaces affects the maximum inclination angle of conveyor and storage bin. The magnitude of frictional force affects the amount of power required to convey the materials. Angle of repose is a useful parameter for calculation of belt conveyor width and for designing the shape of storage. Mechanical properties such as rupture force, hardness and energy used for rupturing are useful information in designing the dehulling or shelling machine and oil extractor. The rupture force indicates the minimum force required for dehulling or shelling and to extract the oil.

Arora, (1991) conducted an experiment to study terminal velocity, drag coefficient and resistance coefficient of three varieties of rough rice. The aerodynamic properties (terminal velocity, drag coefficient and resistance coefficient) were increased with an increase in moisture content.

Konak, *et. al.*, (2002) and Sacilik, *et. al.*, (2003), also found that, as the moisture content increased the values of terminal velocity for both chick pea and hemp seed were found to increase linearly. The increase in terminal velocity with an increase in moisture content can be attributed to the increase in mass of an individual seed per unit frontal area presented to the air stream.

Matouk *et al.*, (2005) studied the effect of increasing moisture content on Aero-dynamic characteristics of different varieties of rice, corn, wheat and barley. They found that, increasing the grain moisture content tended to increase terminal velocity, drag coefficient and Reynold's number of rice, corn, wheat and barley. They stated that, the relationship between terminal velocity and moisture content may be described by an exponential model while, drag coefficient and Reynold's number increased linearly as the moisture content increased.

For chick pea seed, Konak, *et al.*, (2002) found that the rupture strength along any of the three major axes is highly dependent on the moisture content in the range of (5.2–16.5% d.b.). Their results also indicate that greater forces were necessary to rupture the seed with lower moisture. The highest forces were obtained while loading along the Z-axis, whereas loading along the Y- axis required least force to rupture. The small rupturing forces at higher moisture content might have resulted from the fact that the seed became more sensitive to cracking at high moisture.

For wheat, rice, corn and barely, Matouk *et al.*, (2006 a) mentioned that, hardness, shear force and shear stress were decreased linearly with the increase of grain moisture content. They also found that, for different varieties of rice and barely, shear force at the longitudinal direction was higher than lateral direction while it was lower at longitudinal direction than lateral direction for corn and, it was very close in both directions for wheat. Also, shear stress in lateral direction was higher than longitudinal direction for rice and barely. While, they were lower in lateral direction than longitudinal direction for corn and wheat.

Gupta and Das (1997), Aviara, *et al.*, (1999), Also, Balasubramanian, (2001), Özarıslan, (2002), Matouk *et al.*, (2003), Sacilik *et al.*, (2003) and Nimkar *et al.*, (2005), determined the static coefficient of friction for different studied crops at different friction surfaces. They mentioned that, the coefficient of friction was varied with the increased adhesion between the seed and the material surfaces at higher moisture values and type of friction surface. They also found that, the greatest static coefficient of friction was on rubber and the least on stainless steel. This may be owing to smoother and more polished surface of the stainless steel sheet than other materials used.

While, Sahoo and Srivastava, (2002) found that for okra seed, the angle of repose increased as the moisture content increased. A logarithmic relationship was found between the angle of repose and moisture content.

Also, Konak *et al.*, (2002) and Sacilik, *et al.*, (2003) determined the angle of repose for chick pea and hemp seed. The obtained result showed that, the angle of repose increased for chickpea and hemp seed as the moisture content increased. The obtained values of the angle of repose were considerably less than those of pumpkin seed as determined by (Joshi, *et al.*, 1993). This is difference may be due to the higher sphericity of chick pea seed allowing them to slide and roll on each other.

Also, Reddy and Chakraverty, (2004), Dursun and Dursun, (2005) and Matouk *et al.*, (2006 b), stated that, the angle of repose increases linearly with the increase in moisture content. They indicated that, the increase in the angle of repose with increase in moisture content of the seed could be

due to the higher projected area which may increase the internal friction of the seed.

The present study aims to determine aero-dynamic and mechanical properties such as terminal velocity, Reynold's No., drag coefficient, coefficient of friction, repose angle and seeds hardness for three different oil producing crops (sunflower, soybean and canola) at five different levels of seeds moisture content and temperature; while, shear force and shear stress of soy bean hulls and cotyledons were also determined at the proper moisture content for oil extraction.

MATERIALS, EQUIPMENTS AND METHODS

Materials:

Samples of the investigated crops (Sunflower variety Giza 102, Soya bean variety Giza 111 and Canola variety Serow 55) were obtained from the research station of the Agricultural Research Center (ARC), Gimmeza, Experimental Station, Gharbiea Governorate, to grantee the purity of the selected varieties. These varieties were selected based on its recent coverage area and the expected future expansion according to Ministry of Agriculture yearly bulletins (MALR, 2005 a,b). The samples were cleaned to remove impurities, immature kernels and foreign materials. The seeds of each variety were then stored in a burlap sacks inside a ventilated storage room.

Equipments and test procedures:

Terminal velocity apparatus:

Apparatus for measuring the terminal velocity was designed and fabricated according to (Matouk, et al., 2005). All the apparatus parts were rested over a wooden frame as shown in figure (1). The specifications of the apparatus are presented in table (1).

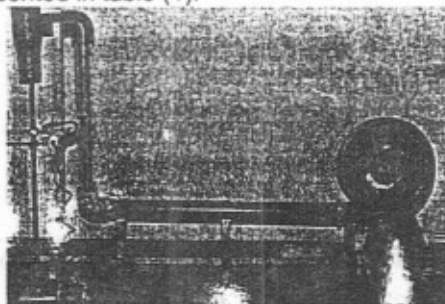

Figure (1): Terminal velocity apparatus

Table(1): The parts and specifications of the terminal velocity apparatus:

1	Dimensions	1 × 0.85 m (Length × Height)
2	Accuracy	0.01 m / sec
3	Maximum air speed	20 – 25 m / sec
4	Materials of tubes and elbows	PVC and transparent glass
5	Centrifugal fan	AC current, 220 V, 50 HZ, 2800 rpm , 0.25 kW
6	Electric inverter	Japan Made 1.5 kW , current HZ control

The procedure steps of terminal velocity measurement were as follows:

- 1-The apparatus was calibrated by gradually measuring the velocity of air passing through the transparent tube and the current frequency of the inverter [the data was analyzed and a direct relationship between the air velocity and the inverter current frequency shown in Figure (2)]. The obtained relationship was used for calculating different air velocities inside the transparent tube during the experimental work without using the prop of air velocity meter which may obstruct the seeds flow inside the tube during the measurements.
- 2-For different levels of seeds moisture content of each studied variety a 100 seed sample in three replicates were randomly selected and placed over the plastic net of the transparent tube.
- 3-The plower was operated and the inverter frequency was gradually increased until the floating air suspends the particle in the vertical active part of the transparent tube. When approaching a relatively steady seeds suspension condition, the suspended seeds were counted and the frequency of the inverter current was recorded.
- 4-The inverter frequency gradually increased until the suspended seeds flow out the transparent tube and with additional increase of the inverter frequency another seeds start to suspend.
- 5-The terminal velocity was calculated using the following equation:

$$V_t = 0.2521 f + 0.0987 \quad (R^2 = 0.9996) \dots\dots\dots(1)$$

where :

V_t = seeds terminal velocity m/ sec

f = inverter current frequency (Hz)

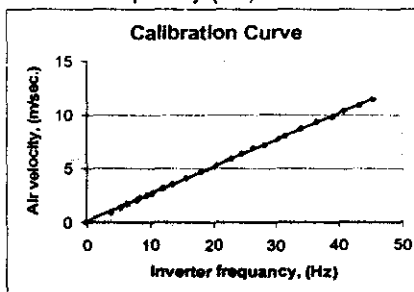

Figure (2): Calibration curve for the terminal velocity apparatus.

Coefficient of friction:

Figure (3) shows the structure features of the digital device which was designed according to (Matouk, et al., 2003). The measuring device consists of the following parts:

1	Lifting unit	0.1 hp motor/24 V
2	receiving box of sample	Plastic 18 x 32 cm
3	Sensing unit	Electronic circuit to control the motor switching (Fig. 4)
4	Responding unit	Photo resistance
5	Display unit	Electronic circuit with a digital screen (Fig. 5)
6	Accuracy	0.1 degree
7	Tested surfaces	rubber, stainless steel and galvanized iron sheets

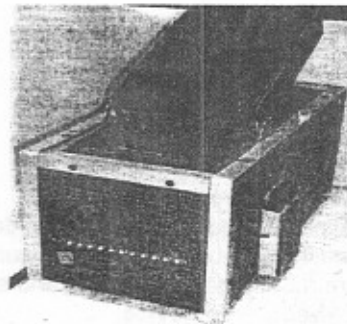

Figure (3): Digital device used for measuring the friction angle.

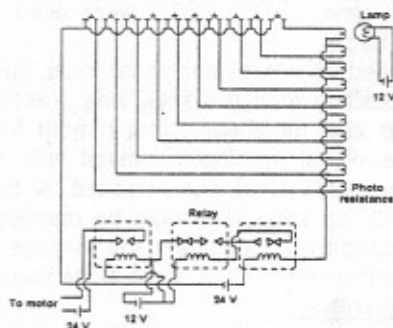

Figure (4): The electronic circuit of sample weight.

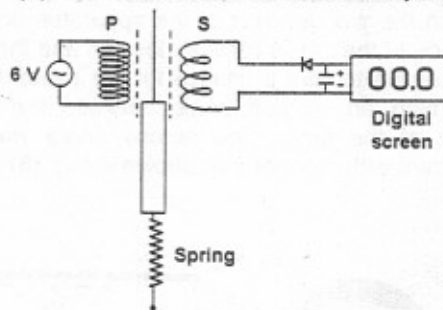

Figure (5): The electronic circuit of friction angle display.

The measuring procedure depends on selecting the required sample weight electronic circuit on the measuring device. For measuring process, a seed sample of 200 gr placed over the surface of the lifting tray and leveled horizontally to cover all the tray surface. The electronic circuit was then switched on then the tray with seed tilted up around to its side pivot and when 50 % of the seed sample fall into the seed receiving box, the electronic circuit will give a signal to the motor to stop the lifting plate and the angle of friction will be displayed on the instrument digital screen. Detailed description of the calibration and measuring procedure had been given by (Matouk, *et. Al.*, 2006).

The coefficient of friction for the tested sample was obtained using the following equation:

$$C.F = \tan \theta, \text{ decimal} \dots\dots\dots (6)$$

Where:

- C.F = coefficient of friction
- θ = friction angle, degree.

The friction angle of the seeds sample considered as the average of three replicates for each surface. The tested surfaces used during the experimental work were rubber, galvanized iron and stainless steel.

Seeds hardness and shear force device:

The hardness and shear force, meter model (FGN-50, USA) with an accuracy of 0.01 N. and a digital LCD were used for measuring seeds hardness and shear force.

For measuring seeds hardness and shear force, the meter was set on the maximum reading position then the seed was pressed by the flat end for hardness and sharp end for shear force in both lateral and longitudinal directions, while the digital reading increased with the increasing of the pressure on the seeds until it has been cracked. At this point the displayed reading means seeds hardness. It should be mentioned that, each tested sample was represented by 50 seeds and the average of the 50 reading was considered as the hardness and shear force of the sample.

Angle of repose apparatus:

Angle of repose apparatus designed by (Matouk, et. al., 2006 b) used for measuring the angle of repose. In this test each sample was taken randomly and then poured in the wooden box of the apparatus until completely filling the box. The surface of the box is carefully leveled and the transparent sliding side is quickly taken up to give a chance for the seeds to flow down under natural slope forming an inclined angle between the box side and the horizontal surface of the table. The repose angle was measured using wooden parallelogram with protractor as shown in Fig. (6)

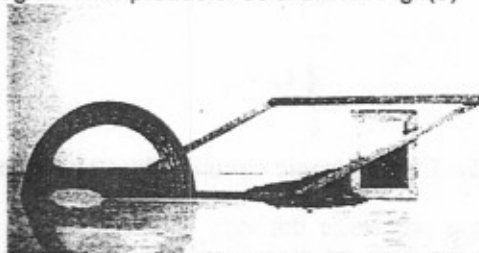

Figure (6): The transparent box and the wooden parallelogram used for measuring the repose angle.

Drag coefficient:

In free fall, the object will attain constant terminal velocity (V_t) at which the net gravitational accelerating force (F_g) equals the resisting upward drag force (F_r) under the condition where terminal velocity has been achieved the air velocity (V) which equal to the terminal velocity (V_t).

Substituting for F_g and F_r , the expression for terminal velocity will be as follows (Mohsenin, 1984):

$$V_t = \sqrt{\frac{2mg(\rho_p - \rho_f)}{\rho_p \rho_f A_p C}}, \text{ m/s} \dots\dots\dots(2)$$

And the drag coefficient can be derived as follows:

$$C = \frac{2mg(\rho_p - \rho_f)}{\rho_p \rho_f A_p V_t^2}, \text{ decimal} \dots\dots\dots(3)$$

Where :

- m = mass of seeds, (kg)
- g = acceleration due to gravity 9.81 m/s²
- ρ_p = mass density of seeds, (kg/m³)
- ρ_f = mass density of air 1.191kg/ m³
- A_p = Projection area of the particle, (m²)
- V_t = terminal velocity, (m/s)
- C = overall drag coefficient

Reynold's Number:

In this study Reynold's number (Re) was calculated using the terminal velocity of each variety since Reynold's number equations include a velocity term using the following relationship:

$$Re = \frac{\rho_f V_t D_g}{\mu}, \text{ dimensionless} \dots\dots\dots(4)$$

The geometric mean diameter of seeds (D_g) could be calculated as follows

$$D_g = \sqrt[3]{L \times W \times Th}, \text{ m} \dots\dots\dots(5)$$

Where :

- ρ_f = mass density of the air 1.191 kg/m³
- V_t = terminal velocity, (m/s)
- μ = air viscosity at room temp., (1.85 x 10⁻⁵) N . sec/m²
- L = seeds length, (m)
- W = seeds width, (m)
- Th = seeds thickness, (m)

RESULTS AND DISCUSSIONS

Aerodynamic properties:

Terminal velocity (V_t):

Figure (7) illustrate the terminal velocity of the studied crops as a function of seeds moisture content. It can be seen that, terminal velocity of sunflower, soybean and canola seeds increased from (5.34 to 5.91), from (10.16 to 10.38) and from (5.10 to 5.32 m/sec) with the increasing of seeds moisture contents from (7.35 to 23.7 %), (9.52 to 24.644 %) and (7.11 to 25.722 % w.b.), respectively.

Also, values of terminal velocity of sunflower kernels and hulls were found to be 5.65 and 3.05 m/sec, respectively. While for soybean, the values of terminal velocity were 6.74 m/sec for the cotyledons and 3.52 m/sec for hulls.

A simple linear regression analyses was applied to relate the change in seeds terminal velocity (V_t) with the change in seeds moisture content. The obtained regression equation was in the form of:

$$V_t = a + b (MC) \dots\dots\dots (7)$$

Where:

V_t = Seeds terminal velocity, m/sec.

a and b = Constants.

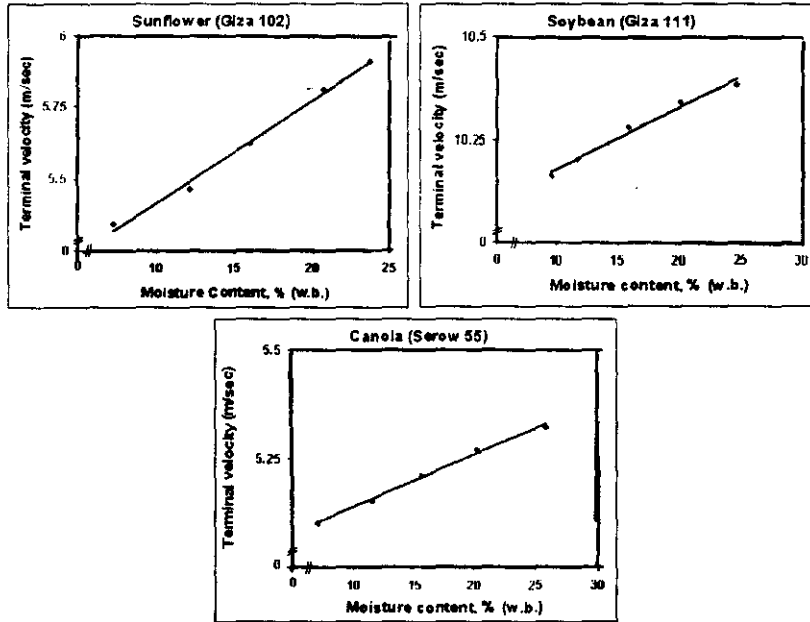

Figure (7): Effect of moisture content on the terminal velocity of different studied crops.

The regression constants (a and b) for the obtained regression equations are tabulated in Table (2).

Table (2): Regression parameters of equation (7) relating the change in seeds moisture contents with the seeds terminal velocity.

Crop	Moisture content, % (w.b.)	Regression parameters		
		a	b	R ²
Sunflower	7.35 - 23.7	5.0397	0.0358	0.982
Soybean	9.52 - 24.644	10.029	0.0148	0.978
Canola	7.11 - 25.722	5.0147	0.0122	0.993

Drag Coefficient (D_t):

As shown in Figure (8), the drag coefficient of sunflower, soybean, and canola seeds, decreased from (0.75061 to 0.6178), from (0.6841 to 0.6829) and from (0.6301 to 0.5687) with the increasing of seeds terminal velocity

from (5.303 to 5.89), from (10.17 to 10.39) and from (5.1 to 5.3 m/sec.), respectively.

A simple linear regression analyses was applied to relate the change in drag coefficient with the change in terminal velocity of the studied crops. The obtained regression equation was in the form of:

$$D_r = c + d (V_t) \dots\dots\dots(8)$$

Where:

D_r = Drag coefficient
 c and d = Constants.

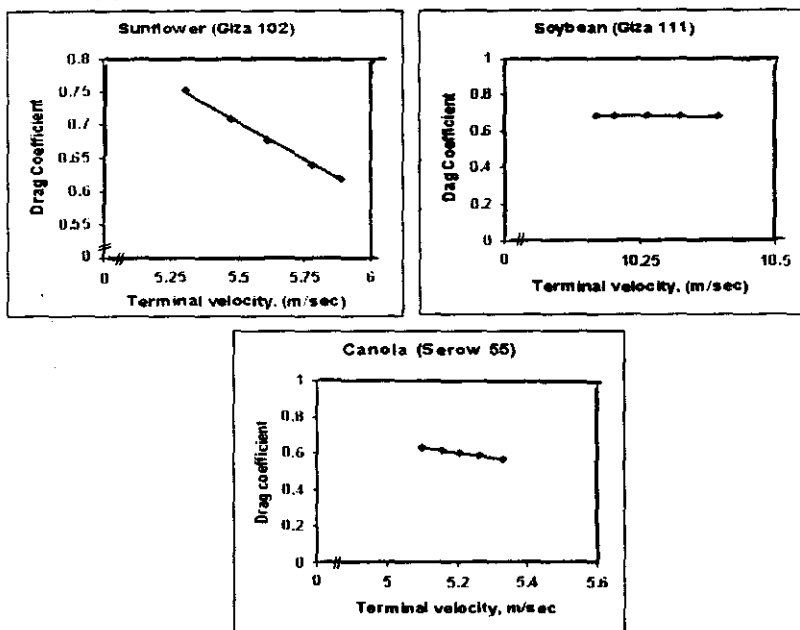

Figure (8): Effect of seeds terminal velocity on drag coefficient of different studied crops.

The regression constants (c and d) are tabulated in Table (3).

Table (3): Regression parameters of equation (8) relating the change in seeds terminal velocity with the drag coefficient.

Crop	Moisture content, % (w.b.)	Regression parameters		
		c	d	R^2
Sunflower	7.35 - 23.7	1.9492	-0.2265	0.998
Soybean	9.52 - 24.644	0.7372	-0.0052	0.984
Canola	7.11 - 25.722	2.0081	-0.2702	0.998

Reynold's Number (R_e):

Renold's No. (Re) for different studied crops was calculated as a function of moisture content. As shown in Figure (9), Reynold's No. of sunflower, soybean and canola seeds was increased from (2226.476 to 2571.506), from (4379.706 to 4652.204) and from (679.044 to 755.238) with the increase of

seeds moisture contents from (7.35 to 23.7%), from (9.52 to 24.644%) and from (7.11 to 25.722%), respectively.

A simple linear regression analyses was applied to relate the change in Reynold's No. with the change in seeds moisture content. The obtained regression equation was in the form of:

$$R_{no} = e + f (V_t) \dots\dots\dots(9)$$

Where:

R_{no} = Reynold's No.
e and f = Constants.

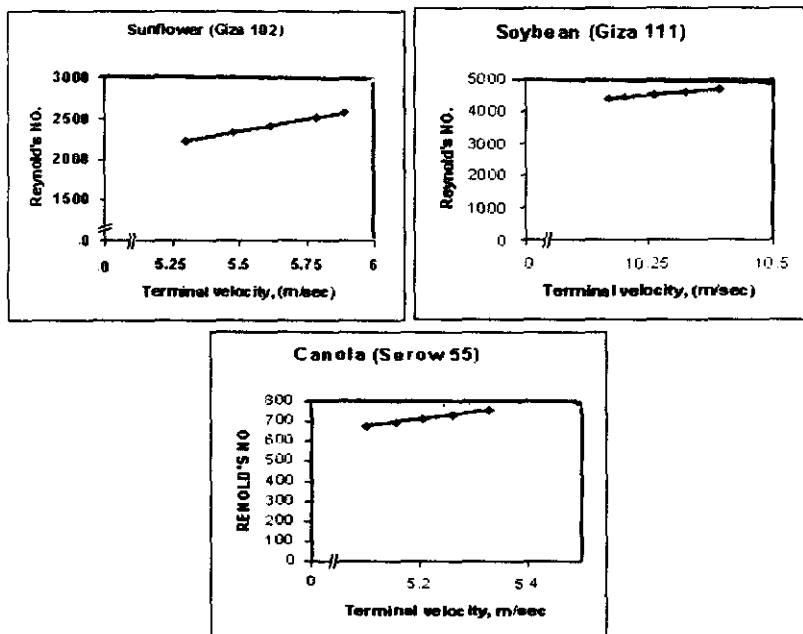

Figure (9): Effect of terminal velocity on Reynold's No. for different studied crops.

The regression constants (e and f) are tabulated in Table (4).

Table (4): Regression parameters of equation (9) relating the change in seeds terminal velocity with Reynold's number.

Crop	Moisture content, % (w.b.)	Regression parameters		
		e	f	R ²
Sunflower seeds	7.35 - 23.7	-901.22	559.59	0.99
Soybean seeds	9.52 - 24.644	-8000.2	1217.3	0.98
Canola seeds	7.11 - 25.722	-1033.3	335.6	0.99

In general, Reynold's No. increased with the increasing of seeds terminal velocity for all studied crops. These results are matching with the results obtained by (Matouk *et. al.*, 2005).

Mechanical Properties:

Coefficient of friction:

In general, for all studied crops the coefficient of friction was varied with seeds moisture content and type of friction surface.

Figure (10) shows the change in friction coefficient as related to seeds moisture content at stainless steel, galvanized iron and rubber surfaces.

For sunflower seeds, the stainless steel surface recorded the lowest values of friction coefficient which increased from (0.2718 to 0.6337), while the rubber surface recorded the highest values which increased from (0.4535 to 0.8035) with the increase of the moisture content from (7.35 to 23.7%).

Also, for soybean, the stainless steel sheet recorded the lowest values of friction coefficient which increased from (0.159 to 0.3225), while the rubber surface recorded the highest values which increased from (0.2087 to 0.41.44) with the increase of moisture content from (9.52 to 24.664%).

For canola seeds, the stainless surface recorded the lowest values of friction coefficient which increased from (0.3322 to 0.4281), while, the rubber surface recorded the highest values which increased from (0.3688 to 0.5054) with the increase of moisture content from (7.11 to 25.722%).

To relate the change in coefficient of friction with the change in seeds moisture content the following regression equation was obtained:

$$C_f = g + h (MC) \dots\dots\dots(10)$$

Where:

C_f = coefficient of friction.

g and h = Constants.

On the other hands, the coefficients of friction for sunflower kernels, crushed soybean and crushed canola at stainless steel surface were 0.5039, 0.7359 and 0.5039 at moisture content of 6.33, 9.52 and 7.11 % w.b., respectively.

The regression constants (g and h) are tabulated in Table (5).

Table (5): Regression parameters of equation (10) relating the change in friction coefficient with the change in seeds moisture content.

Crop	Tested surfaces	Regression parameters		
		g	h	R ²
Sunflower seeds	Rubber	0.2663	0.0234	0.991
	G Iron	0.2032	0.0239	0.983
	S. Steel	0.0837	0.0237	0.983
Soybean seeds	Rubber	0.0737	0.0134	0.987
	G Iron	0.0529	0.0112	0.988
	S. Steel	0.0496	0.0101	0.973
Canola seeds	Rubber	0.3108	0.0075	0.973
	G Iron	0.3136	0.0059	0.996
	S. Steel	0.2982	0.0051	0.996

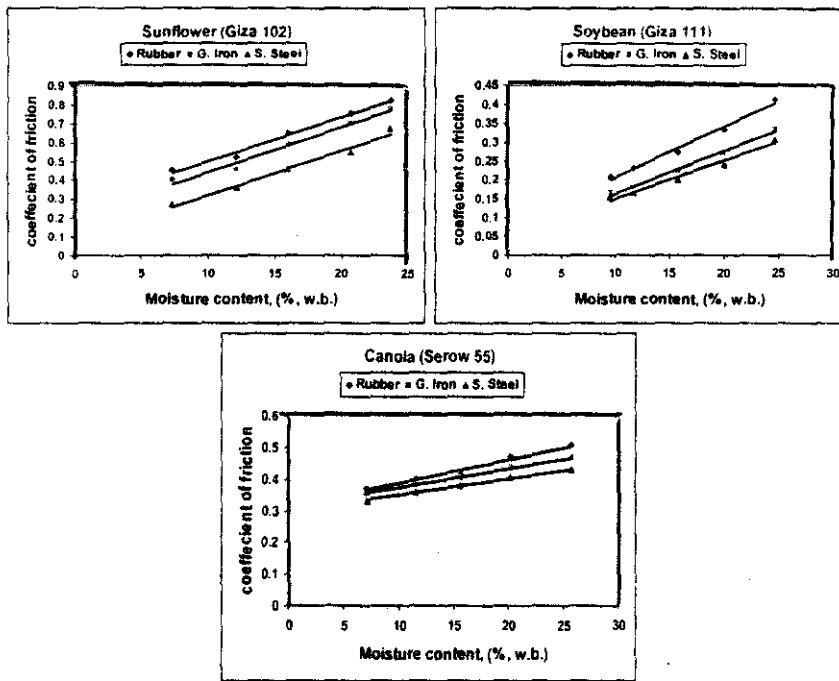

Figure (10): Effect of moisture content on friction coefficient of different studied crops at different tested surfaces.

The same trend was also obtained by (Gupta and Das, 1997, Özarslan, 2002 and Matouk *et al.*, 2003) for sunflower seeds, cotton seeds and rice, wheat, corn and barely, respectively.

Angle of repose:

As shown in Fig. (11), the angle of repose for different studied crops increased with the increase of moisture content.

For sunflower seeds, the angle of repose increased from (31.08° to 39.83°) with the increase of seeds moisture content from (7.35 to 23.7 % w.b.)

While for soybean seeds, the angle of repose increased from (28° to 33.58°) with the increase of seeds moisture content from (9.52 to 24.644 % w.b.). Also for canola seeds, the angle of repose increased from (27.33° to 31.17°) with the increase of seeds moisture content from (7.11 to 25.722 % w.b.).

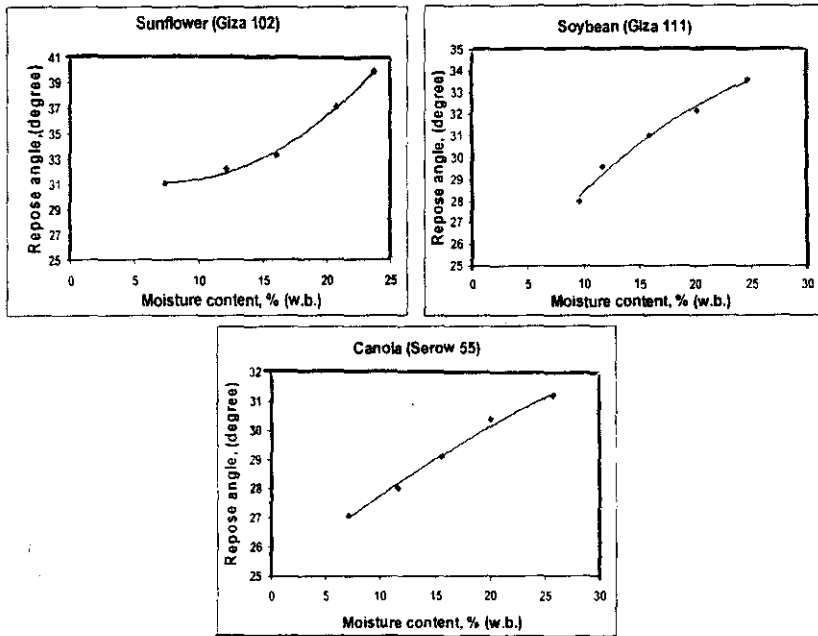

Figure (11): Effect of moisture content on angle of repose for different studied crops.

This was clear from the results of regression analysis which show a direct simple linear relationship between the seeds moisture content and the repose angle on the form of:

$$R_a = i (MC)^2 + j (MC) + k \dots\dots\dots (11)$$

Where:

- R_a = angle of repose, degree.
- MC = seeds moisture content % (w.b.).
- i, j and k = Constants.

The regression parameters of equation (11) were presented in Table (6).

Table (6): Regression parameters of equation (11) relating the change in repose angle with the change in seeds moisture content.

Crop	Range of seeds moisture content, % w.b.	Regression parameters			
		i	j	k	R ²
Sunflower	7.35 – 23.7	0.0324	-0.4761	32.926	0.995
Soybean	9.52 – 24.644	-0.01	0.6911	22.553	0.989
Canola	7.11 – 25.722	-0.0017	0.2786	25.276	0.973

On the same time, the measured values of repose angle for sun flower kernels, crushed soybean and crushed canola were 35.52, 32.67 and 36.83 °, at moisture contents of (6.33, 9.52 and 7.11 %), respectively.

These results are in agreement with those obtained by (Gupta and Das, 1997, Soliman, 1994, Aviara *et al.*, 1999, Baryeh, 2001 and Matouk *et al.*, 2006b) for sunflower seeds, paddy rice, guna seeds, bambara groundnuts and rice, wheat, corn and barely, respectively. They mentioned that, as the force of solid friction increased, the angle of repose also increased.

Seeds hardness:

As shown in Fig. (12), the recorded seeds hardness for sunflower decreased from (46.24 to 18.862 N) with the increase of moisture content from (7.35 to 23.7 %) while, the kernels hardness decreased from (19.68 to 8.56 N) with the increased of moisture content from (6.33 to 22.57 %).

For soybean, the seeds hardness decreased from (83.27 to 46.01 N) with the increase of moisture content from (9.52 to 24.644 %).

While, for canola, the seeds hardness decreased from (12.35 to 5.54 N) with the increase of moisture content from (7.11 to 25.722 %).

A simple regression analysis was also proceeded to relate the change of seeds moisture content with hardness. The obtained relationship was as follow:

$$H = l + m (MC), N \dots\dots\dots (12)$$

The regression constants (l and m) are tabulated in Table (7).

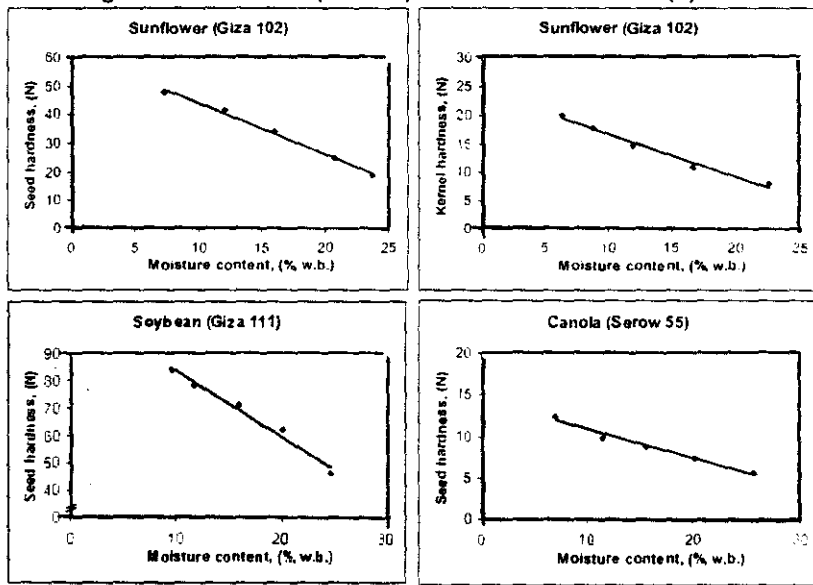

Figure (12): Effect of moisture content on seeds hardness of different studied crops.

Table (7): Regression parameters of equation (12) which relates the change in seeds and kernels hardness with the change in moisture content.

Crop		Moisture content, % (w.b.)	Regression parameters		
			l	m	R ²
Sunflower	Seeds	7.35 - 23.7	60.191	-1.713	0.987
	kernels	6.33 - 22.57	23.998	-0.7205	0.969
Soybean		9.52 - 24.644	106.86	-2.3905	0.966
Canola		7.11 - 25.722	14.373	-0.352	0.979

Shear force and shear stress of soybean hull and cotyledons:

The measured shear force and the calculated shear stress of soybean hulls and cotyledons on both lateral and longitudinal direction were tabulated in Table (8). From the data presented in the Table, shear force and shear stress of seed cotyledons on the longitudinal direction recorded higher values of 88.55 N and 5.16 N/mm², respectively, in comparison with the shear force and shear stress on the lateral directions which recorded values of 54.6 N and 3.74 N/mm², respectively. On the same time, shear force and shear stress of soybean hulls were found to be 51.45 N and 1.30 N/mm², respectively.

Table (8): The statistical analysis of hulls and cotyledons shear force and shear stress for soybean seeds:

Moisture content, % (w.b.)		Shear force, (N)			Shear stress, (N/mm ²)		
		Hulls	Cotyledons		Hulls	Cotyledons	
			Lat. D.	Long. D.		Lat. D.	Long. D.
Soybean	Mean	51.45	54.60	88.55	1.30	3.74	5.16
	Minimum	30.60	34.40	51.90	0.72	1.29	2.62
	Maximum	74.60	87.60	116.40	2.03	6.42	6.97
	S.D.	10.849	16.973	16.131	0.3014	1.1776	1.0356
	C.V.	115.352	282.313	254.996	0.0890	1.3591	1.0511

CONCLUSION

- 1- Terminal velocity and Reynold's No. of all studied crops increased linearly with the increase of seeds moisture content. While, drag coefficient decreased with the increase of terminal velocity.
- 2- Coefficient of friction was varied with roughness of seeds surfaces, moisture content and type of friction surface. Also, it was increased with the increase of seeds moisture content for all studied crops.
- 3- Angle of repose increased with the increasing of moisture content. While, seeds hardness decreased.
- 4- Both shear force and shear stress of soybean hulls and cotyledons were higher in the longitudinal direction in comparison with the lateral direction.

REFERENCES

Arora S., (1991). "Physical and aerodynamic properties of rough rice (*Oryza sativa*)". *Indian Journal of Agric. Eng.* 1:1, 17-22.

- Aviara, N. A., M. I. Gwandzang and M. A. Haque, (1999). "Physical Properties of Guna Seeds". *J. Agric. Engng. Res.*, (73): 105-111.
- Balasubramanian D., (2001). "Physical Properties of Raw Cashew Nut". *J. Agric. Engng. Res.*, Vol. 78 (3): 291-297.
- Dursun, E. and I. Dursun, (2005). "Some Physical Properties of Caper Seed". *J. of Biosystems Engng.* Vol. 92(2): 237 – 245.
- Gupta, R. K. and S. K. Das, (1997). "Physical properties of sunflower seeds". *J. Agric. Engng. Res.*, (66): 1-8.
- Joshi D. C., S. K. Das and R. K. Mukherjee, (1993). "Physical properties of pumpkin seeds". *J. of Agric. Engng. Res.* Vol. 54: 219–229.
- Konak, M., K. Carman and C. Aydin, (2002). "Physical Properties of Chick Pea Seeds". *J. of Biosystems Engng.* Vol. 82 (1):73–78.
- MALR, (2005 a). "Study of the indicators agricultural statistics". Cent. Admin. Agric. Economic, Economic Affairs Sector, MALR., A.R.E. Vol. (1).
- MALR, (2005 b). "Study of the indicators agricultural statistics". Cent. Admin. Agric. Economic, Economic Affairs Sector, MALR., A.R.E. Vol. (2).
- Matouk A. M., A. S. Hamam, M. M. El-Kholy and S. M. Radwan (2006 b). "Effect of grain moisture content on repose angle of some varieties of cereal crops". *J. of Agric. Sci., Mansoura Univ.* Vol. 31 (5): 2957-2964.
- Matouk A. M., M. M. El-Kholy, A. S. Hamam and T. R. Ewis, (2005). "Aero-Dynamic characteristics for different varieties of some cereal crops". *Misr J. Agric. Engng.* Vol. 22 (3): 1086-1102.
- Matouk A. M., M. M. El-Kholy, S. M. Radwan and T. R. Ewis, (2006 a). "Effect of moisture content on mechanical properties of some cereal grain". *Misr J. Agric. Engng.* Vol. 23 (3): 217-231.
- Matouk, A. M., M. M. El-Kholy and S. M. Radwan, (2003). "Determination of friction coefficients for different varieties of some cereal crops". *J. of Agric. Sci., Mansoura Univ.* Vol. 28 (9): 6905-6921.
- Mohsenin, N. N., (1984). "Physical properties of plant and animal materials". Gordon and Breach Sc. Pub., N.Y. pp. 734 .
- Nimkar, P. M., Dipali S. Mandwe and Renu M. Dudhe, (2005). "Physical Properties of Moth Gram". *J. of Biosystems Engng.* Vol. 91 (2): 183–189.
- Özarslan, C., (2002). "Physical Properties of Cotton Seed". *J. of Biosystems Engng.* Vol. 83 (2):169–174.
- Reddy B. S. and A. Chakraverty, (2004). "Physical Properties of Raw and Parboiled Paddy". *J. of Biosystems Engng.* Vol. 88 (4): 461–466.
- Sacilik, K., R. Öztürk and R. Keskin, (2003). "Some Physical Properties of Hemp Seed". *J. of Biosystems Engng.* Vol. 86 (2): 191–198.
- Sahoo P. K. and A. P. Srivastava, (2002). "Physical Properties of Okra Seed". *J. of Biosystems Engng.* Vol. 83(4):441–448.
- Soliman, N. S., (1994). "Effect of moisture content on angle of repose of paddy rice and its products". *Misr, J. Agric. Engng.* Vol. 11(1): (163 - 173).

الخصائص الإيرووديناميكية والميكانيكية لبعض المحاصيل المنتجة للزيت أحمد محمود معنوق ، صلاح مصطفى عبد اللطيف و أحمد ثروت قسم الهندسة الزراعية - كلية الزراعة - جامعة المنصورة.

تم تعيين كل من الخصائص الإيرووديناميكية والخصائص الميكانيكية المتمثلة في السرعة الحرجة ورقم رينولد ومعامل الجرف ومعامل الاحتكاك وزاوية المكوث وصلابة البذور لثلاثة من المحاصيل المنتجة للزيت وهي عباد الشمس صنف جيزة ١٠٢ وفول الصويا صنف جيزة ١١١ والكانولا صنف سرو ٥٥ عند خمس مستويات مختلفة من المحتوى الرطوبي بينما تم تعيين قوى القص وإجهادات القص (في اتجاه المحور الطولي والمحور العرضي للبذور) لكل من قشرة وفلقات فول الصويا عند المحتوى الرطوبي المستخدم لعملية استخلاص الزيت.

ولقد أوضحت النتائج أن قيم كل من السرعة الحرجة ورقم رينولد لجميع المحاصيل موضع الدراسة قد زادت خطياً بزيادة المحتوى الرطوبي للبذور في حين انخفضت قيم معامل الجرف خطياً بزيادة قيم السرعة الحرجة. كما أوضحت النتائج أن هناك تأثير واضح لكل من المحتوى الرطوبي للبذور ونوع سطح الاحتكاك المستخدم على قيم معامل الاحتكاك حيث زادت قيم معامل الاحتكاك خطياً مع زيادة المحتوى الرطوبي للبذور في حين كانت قيم معامل الاحتكاك عند استخدام الصلب الغير قابل للصدأ أقل من قيم معامل الاحتكاك عند استخدام الصاج المجلفن أقل منها عند استخدام السطح المطاطي. أيضاً زادت قيم زاوية المكوث للبذور بزيادة المحتوى الرطوبي للبذور في حين انخفضت قيم الصلابة للبذور موضع الدراسة. بينما كانت قيم قوى القص وإجهادات القص لكل من قشرة وفلقات فول الصويا في الاتجاه الطولي للبذرة أعلى منها في الاتجاه العرضي.

أيضاً تم تطوير بعض العلاقات الرياضية والتي تصف طبيعة التغير في قيم الخصائص الإيرووديناميكية والميكانيكية المختلفة تبعاً للتغير في المحتوى الرطوبي للمحاصيل موضع الدراسة.